

CABLE TROLLEYS for C-rail 30x32 mm Flatcable

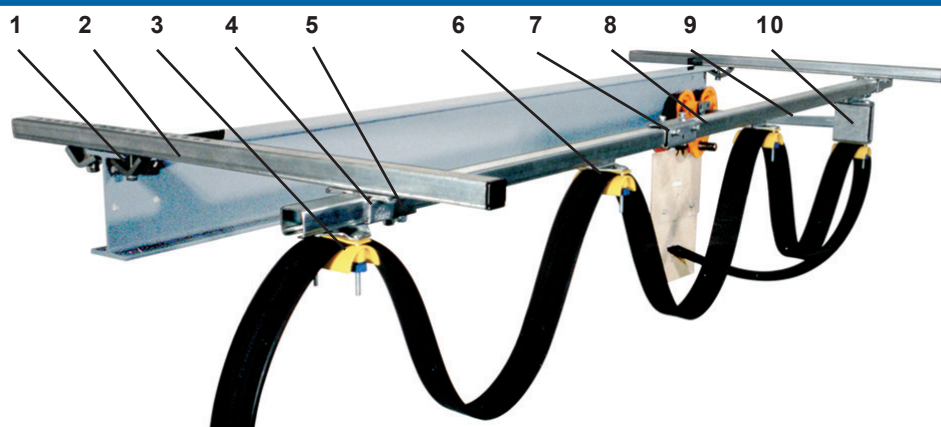

Sheet 11-32 2016



1. Girder clips
2. Support arm
3. End clamp
4. Support bracket
5. End stop
6. Cable trolley
7. Track coupler
8. C-rail
9. Towing arm
10. Towing trolley

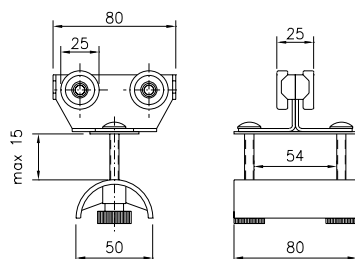
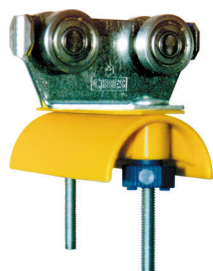

Cable trolley with 4 wheels for flat cable

Material: Galvanized steel body
Wheel with dustproof bearings
Polyamide Cable clamp

Cable load, kg: 20
Weight, kg: 0,28
Article No.: 11 312

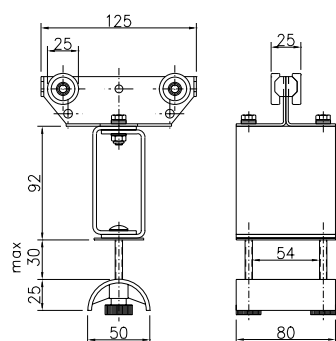

Towing trolley

Material: Galvanized steel body and towing box
Wheel with dustproof bearings
Polyamide Cable clamp

Cable load, kg: 20
Weight, kg: 0,6
Article No.: 11 767

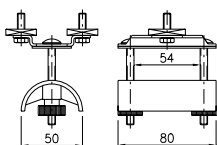

End clamp

Material: Polyamide, Galvanized steel

Weight, kg: 0,2
Article No.: 11 780



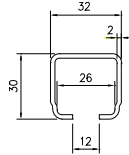

C-rail

Material: Galvanized steel
 Length, mm: 4000 6000
 Weight, kg: 6,2 9,3
 Article No.: 11 900 11 801

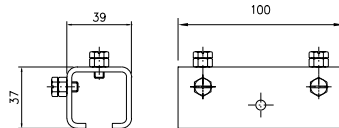

Track coupler

Material: Galvanized steel
 Weight, kg: 0,28
 Article No.: 11 810

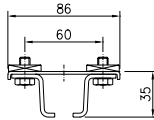

Support bracket with square nuts

Material: Galvanized steel
 Weight, kg: 0,24
 Article No.: 11 820

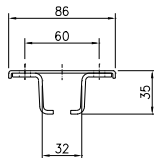

Support bracket for ceiling mounting

Material: Galvanized steel
 Weight, kg: 0,16
 Article No.: 11 825

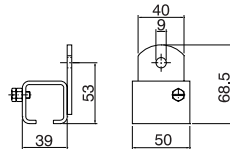

Support bracket for wall mounting

Material: Galvanized steel
 Weight, kg: 0,20
 Article No.: 11 830

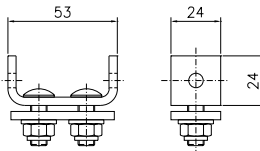
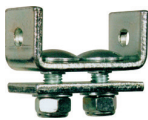

End stop

Material: Galvanized steel
 Weight, kg: 0,13
 Article No.: 11 841

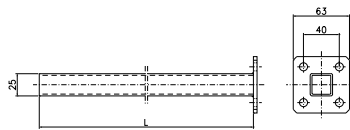

Towing arm

Material: Galvanized steel
 Length, mm: 400 630
 Weight, kg: 0,6 0,8
 Article No.: 11 701 11 702

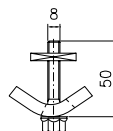

Girder clips 2 for each support arm

Material: Galvanized steel
 Weight, kg: 0,15
 Article No.: 11 737

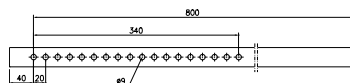

Support arm

Material: Galvanized steel
 Length, mm: 800
 Weight, kg: 1,25
 Article No.: 11 723

